

E010H-E SERIES .163" (4.14mm) pitch HOUSING

Features:

- * MAT'L: NYLON66 UL94 V-2
- * MATES E010 SERIES TERMINAL
- * ACCEPTS WITH: : E110H SERIES HOUSING

unit:mm

E010H-01E

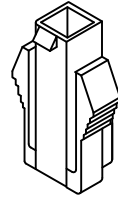

E010H-02E



E010H-03E

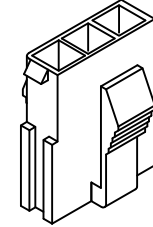

E010H-04E

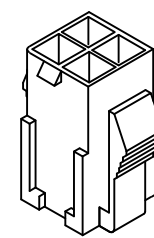

E010H-06E
(2X3)

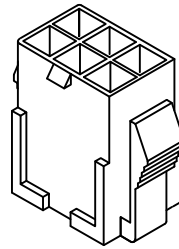

E010H-09E
(3X3)

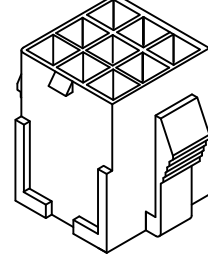

E010H-12E
(3X4)

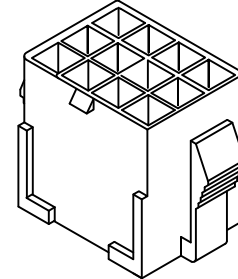

E010H-15E
(3X5)

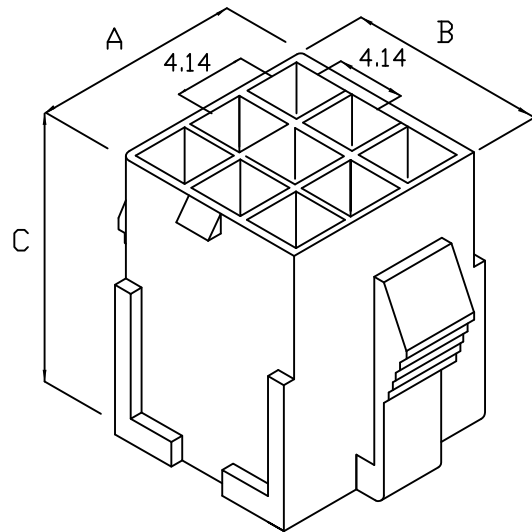
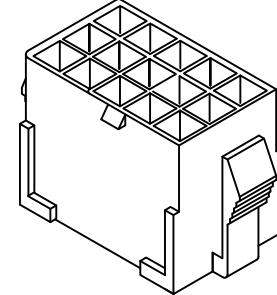

PRAT NO	A	B	C
E010H-01E	5.6	5.6	24.0
E010H-02E(2X1)	9.8	5.6	24.0
E010H-03E(3X1)	14.0	5.6	24.0
E010H-04E(2X2)	9.8	9.8	24.0
E010H-06E(2X3)	9.8	14.0	24.0
E010H-09E(3X3)	14.0	14.0	24.0
E010H-12E(3X4)	14.0	18.5	24.0
E010H-15E(3X5)	14.0	22.5	24.0