

DIP TYPE SERIES

unit:mm

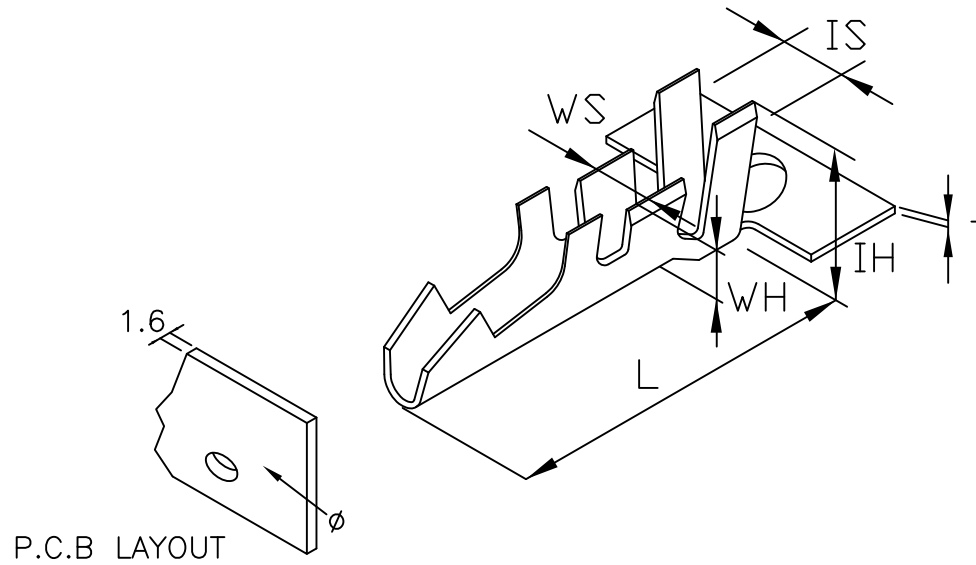

D122

PART/NO.	WIRE RANGE	T	L	WS	WH	IS	IH	P.C.B(φ)	C/W	P.C.B(T)	MATERIAL	FINISH
D122	AWG#18-22	-	5.75	2.1	2.3	4.3	4.0	1.8	1.55	1.2-1.6	BRASS	Tin-plated